

RT16/20P_{r0} RT16/20B

We promise, We deliver



ФАНЛИФТТРАК

Адрес: 142450, Московская обл.,
г. Старая Купавна, ул. Дорожная,
12К, стр. 2, п. 89А

Тел: 8-800-234-16-70
Сайт: funlift.ru
Email: info@funlift.ru

Features:

- Safe and reliable
- Energy efficient
- Strong chassis and excellent view
- Comfortable driving and easy operation
- Optional function



Small
Turning Radius



Capacity
1600-2000kg



Easy
Maintenance



Powerful
Battery



Robust
Design



Low noise

RT16/20Pro-16/20B

Safe and reliable:

- The tilting of the fork can effectively improve the stability of the whole vehicle and the loading capacity at height.
- The electro-hydraulic proportional control system has good fretting performance, more stable work and more precise control.
- Speed limit function, when the forklift lifts to a certain height, the driving speed of the forklift will automatically decrease to ensure the safety of high position operation.
- The height limit function, the lifting motor will automatically power off to ensure the safety of lifting when the forks lift to the maximum height.
- Turning speed limit control prevents the truck from tipping sideways when turning, ensuring the safety of the truck when turning.
- Smooth deceleration when the mast reaches/backwards to the end can ensure the stability of the mast movement.
- The motor temperature detection and control can effectively prevent the motor from being damaged due to excessive temperature.
- The motor current detection and control can effectively prevent the motor from being damaged due to excessive current.
- The combination of electromagnetic brake and hydraulic brake has a short braking distance, no deviation, no impact, and is safe and reliable.
- The parking electromagnetic brake can realize the one-key start operation function no matter it is on the slope or on the smooth ground.
- Using CAN bus communication technology, electrical wiring is simple, the compatibility is good, and the reliability is high.
- AC frequency conversion speed control technology enables stepless closed-loop speed control of driving, lifting, and steering drives, which is accurate and reliable.

Energy efficient:

- High-speed lifting and lowering control improves your work efficiency.
- It adopts AC drive motor, hydraulic pump motor and steering motor, with long service life, maintenance-free and reliable performance.
- Regenerative braking to achieve energy recovery and extend battery life.
- All lights use LED, durable and energy-saving.

Robust Design & Excellent Stability



■ The powerful chassis structure and reasonable center of mass distribution make the forklift have excellent stability.



■ The large arc of the back wall of the chassis coincides with the turning radius of the vehicle, which is beautiful and has a small turning radius.



■ The reasonable layout of the lifting cylinder and pipeline system, the mast pipeline is simple and beautiful, and the vision is good.



■ The high-precision forward sliding rail and excellent clearance compensation design make the forward movement of the masts more stable.

Optional function



■ Side battery extraction.

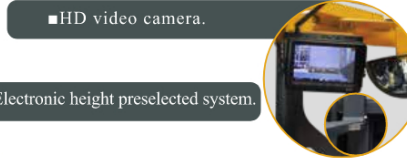

■ HD video camera.



■ Electronic height preselected system.

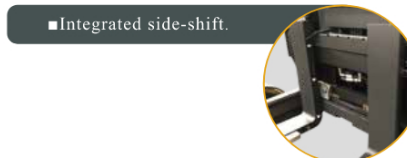

■ Integrated side-shift.



Comfortable driving and easy operation



■ The spacious driving space and ergonomic layout reflect the humanized design of the vehicle.



■ Multi-function color LCD instrument can display information such as steering wheel position, battery power, power alarm, fault code, running time, driving speed etc. The driving speeds of low, medium and high third gear can be set through the meter.



■ Low-noise gear hydraulic pump reduces the lifting noise of the whole vehicle. Travel motor controllers, hydraulic pump motor controllers and steering motor controllers of international well-known brands are self-protected, maintenance-free, and have superior performance.



■ Shock-absorbing seat, adjustable backrest, and seat belt as standard.

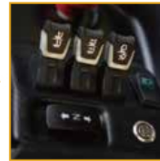

■ Centralized control console, fingertip operation, convenient and accurate.

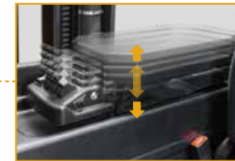

■ The steering wheel and central control console can be adjusted freely in all directions to suit your best operating habits.

■ Adopting AC EPS electronic power steering system, the steering is light and has automatic centering function, and the 180°/360° steering mode can be switched in real time.

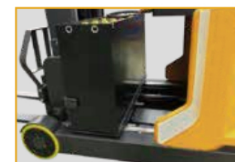

■ In order to replace the battery its tray should be reached forwards. The mechanism for battery's tray release is located near with operator's foot.



Type sheet for industrial truck acc. to VDI 2198

Model	Lift height h3 (mm)	Free lift h2 (mm)	Mast height h1 (mm)	Load capacity kg	Tilt of fork α/β (°)
16M450	4500	1563	2235	1600	4°/2°
16M500	5000	1730	2400	1600	4°/2°
16M550	5500	1897	2568	1600	4°/2°
16M600	6000	2063	2735	1600	4°/2°
16M650	6500	2230	2900	1500	4°/2°
16M700	7000	2397	3068	1400	4°/2°
16M750	7500	2563	3234	1200	4°/2°
16M800	8000	2730	3400	1000	4°/2°
16M850	8500	2897	3567	900	4°/2°
16M900	9000	3063	3734	800	4°/2°
16M950	9500	3230	3900	600	4°/2°
20M450	4500	1563	2235	2000	4°/2°
20M500	5000	1730	2400	2000	4°/2°
20M550	5500	1897	2568	2000	4°/2°
20M600	6000	2063	2735	2000	4°/2°
20M650	6500	2230	2900	1900	4°/2°
20M700	7000	2397	3068	1800	4°/2°
20M750	7500	2563	3234	1600	4°/2°
20M800	8000	2730	3400	1400	4°/2°
20M850	8500	2897	3567	1200	4°/2°
20M900	9000	3063	3734	1000	4°/2°
20M950	9500	3230	3900	800	4°/2°
20M1000	10000	3397	4067	900	4°/2°
20M1050	10500	3563	4234	800	4°/2°
20M1100	11000	3730	4400	700	4°/2°
20M1150	11500	3897	4567	600	4°/2°
20M1200	12000	4063	4733	550	4°/2°
20M1250	12500	4230	4900	500	4°/2°

Types	RT20P		
	Door frame 9500mm		
h3 (mm)	Q (kg)		
9500	800	600	400
9000	1000	700	600
8500	1200	900	800
8000	1400	1100	1000
7500	1600	1300	1200
7000	1800	1500	1400
6500	2000	1700	1600
C (mm)	600	700	800

Types	RT16P		
	Door frame 9500mm		
h3 (mm)	Q (kg)		
9500	600	400	200
9000	800	500	300
8500	900	600	400
8000	1000	750	500
7500	1200	950	700
7000	1400	1150	900
6500	1600	1300	1100
C (mm)	600	700	800

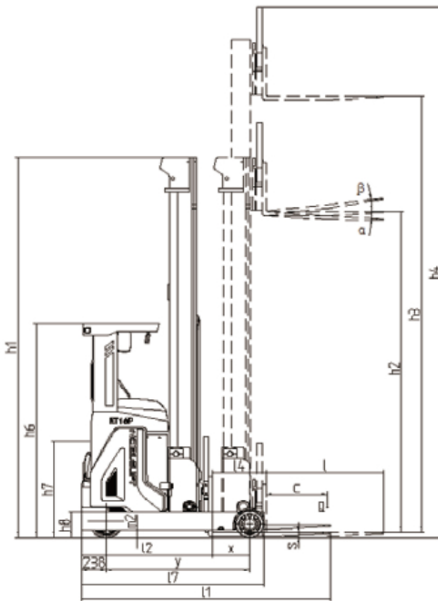
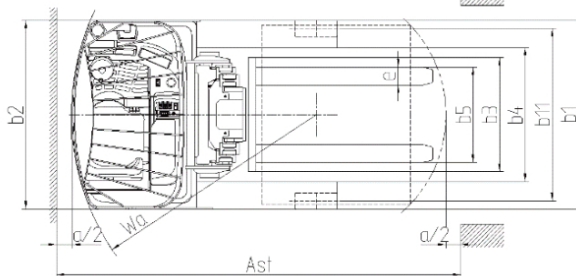

Type sheet for industrial truck acc. to VDI 2198

Identification						
1.1	Manufacturer	HYPER				
1.2	Model	RT16Pro	RT20Pro	RT16B	RT20B	
1.3	Drive	Electric	Electric	Electric	Electric	
1.4	Operator type	Seated	Seated	Seated	Seated	
1.5	Load capacity / rated load	Q (kg)	1600	2000	1600	2000
1.6	Load centre	c (mm)	600	600	600	600
1.8	Load distance, centre of support arm wheel to face of forks	x (mm)	365/176	395/200	365/176	395/200
1.9	Wheelbase	y (mm)	1400	1500	1400	1500
Weights						
2.1	Service weight including battery	kg	3960	4220	3990	4250
2.3	Axle load, mast retracted without load, drive/support arm wheel	kg	2420/1540	2560/1660	2450/1540	2580/1670
2.4	Axle load, mast extended with load, drive/support arm wheel	kg	830/4760	746/5474	890/4700	766/5484
2.5	Axle load, mast retracted with load, drive/support arm wheel	kg	2100/3460	2270/3950	2180/3410	2290/3960
Wheels						
3.1	Drive/support arm wheel		PU	PU	PU	PU
3.2	Wheel size, front	\varnothing xw (mm)	\varnothing 343 x140	\varnothing 343X140	\varnothing 343X140	\varnothing 343X140
3.3	Wheel size, rear	\varnothing xw (mm)	\varnothing 285X110	\varnothing 330X110	\varnothing 285X110	\varnothing 330X110
3.5	Wheels, number front/rear (x=driven wheels)		1x/2	1x/2	1x/2	1x/2
3.7	Track width, rear	b ₁₁ (mm)	1160	1160	1160	1160
Dimensions						
4.1	Tilt of fork, forward/backward	α/β (°)	4°/2°	4°/2°	4°/2°	4°/2°
4.2	Height, mast extended	h ₁ (mm)	3900	3900	3900	3900
4.3	Free lift	h ₂ (mm)	3290	3290	3290	3290
4.4	Lift height	h ₃ (mm)	9500	9500	9500	9500
4.5	Extended mast height	h ₄ (mm)	10410	10410	10410	10410
4.7	Height of overhead guard (cab)	h ₅ (mm)	2200	2200	2200	2200
4.8	Seat height	h ₆ (mm)	960	960	960	960
4.10	Height of support arms	h ₇ (mm)	270	270	270	270
4.15	Height of lowered forks	h ₁₀ (mm)	40	40	40	40
4.19	Overall length	l ₁ (mm)	2412	2488	2412	2488
4.20	Length to face of forks	l ₂ (mm)	1262	1338	1262	1338
4.21	Overall width	b ₁ (mm)	1270	1270	1270	1270
4.22	Fork dimensions	s/e1 (mm)	35/100/1150	40/120/1150	35/100/1150	40/120/1150
4.23	Fork carriage ISO 2328, class/type A, B		2/A	2/A	2/A	2/A
4.25	Width across forks	b ₂ (mm)	200-740	240-740	200-740	246-740
4.26	Distance between support arms	b ₃ (mm)	900	900	900	900
4.28	Reach distance	l ₃ (mm)	525	595	525	595
4.31	Ground clearance, with load, below mast	m ₁ (mm)	90	90	90	90
4.32	Ground clearance, centre of wheelbase	m ₂ (mm)	75	75	75	75
4.33	Aisle width for pallets 1000 x 1200 crossways	Ast(mm)	2720	2840	2720	2840
4.34	Aisle width for pallets 800 x 1200 lengthways	Ast(mm)	2780	2900	2780	2900
4.35	Turning radius	Wa (mm)	1650	1750	1650	1750
4.37	Length across support arms	l ₄ (mm)	1780	1900	1780	1900
Performance data						
5.1	Travel speed, with/without load	km/h	10.5/10.5	10.5/10.5	10.5/10.5	10.5/10.5
5.2	Lift speed, with/without load	m/s	0.35/0.5	0.35/0.5	0.35/0.5	0.35/0.5
5.3	Lowering speed, with/without load	m/s	0.45/0.45	0.45/0.45	0.45/0.45	0.45/0.45
5.4	Reach speed, with/without load	m/s	0.1/0.1	0.1/0.1	0.1/0.1	0.1/0.1
5.8	Max. gradeability, with/without load	%	10/10	10/10	10/10	10/10
5.10	Service brake		Hydraulic/electric	Hydraulic/electric	Hydraulic/electric	Hydraulic/electric
Electric motor						
6.1	Drive motor rating S2 60 min	kW	6.4	6.4	6.4	6.4
6.2	Lift motor rating S3 15%	kW	12.5	12.5	12.5	12.5
6.4	Battery voltage, nominal capacity K5	V/Ah	48/420	48/560	48/420	48/560
6.5	Battery weight	kg	750	950	750	950
Other						
8.1	Type of drive control		AC	AC	AC	AC
8.4	Sound level at the driver's ear according to EN 12 053	dB(A)	68	68	68	68